

EMT/320

FRESA UGUALIZZATRICE

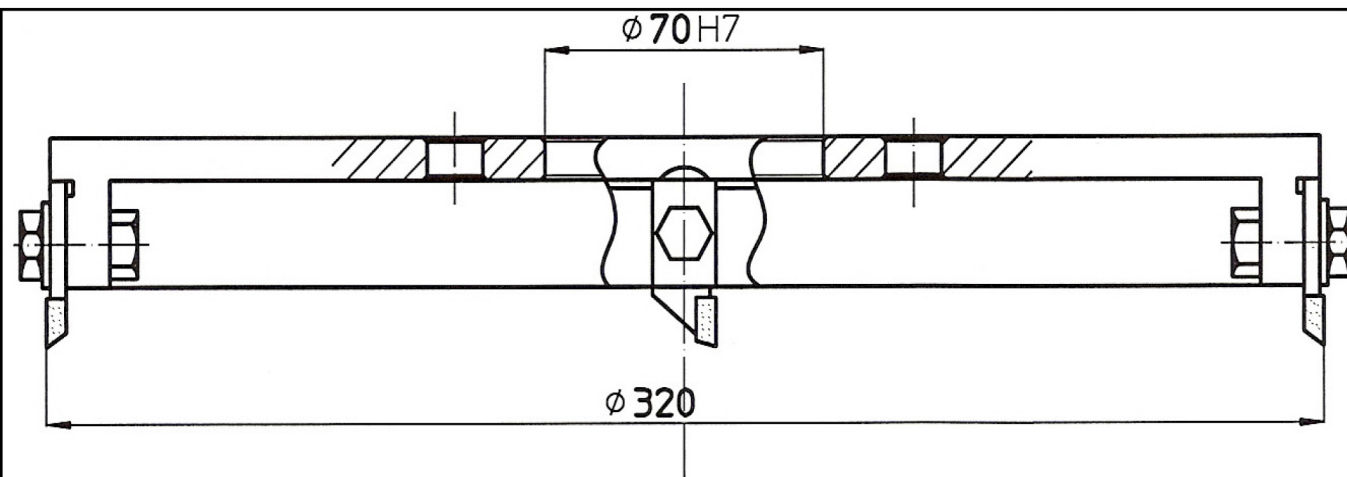

Fresa per **ugualizzare** lo spessore delle suole con **coltelli** di ricambio
Utilizzazione: **cuoio**

Equalizing cutter with **knives**
Utilization: **leather**

Fresa por **igualizar** las suelas con **cuchillas**
Utilización: **cuero**

鞋底厚度均匀制做铣刀 - 适用于：皮革

TEMPLIER

65

COL

4694

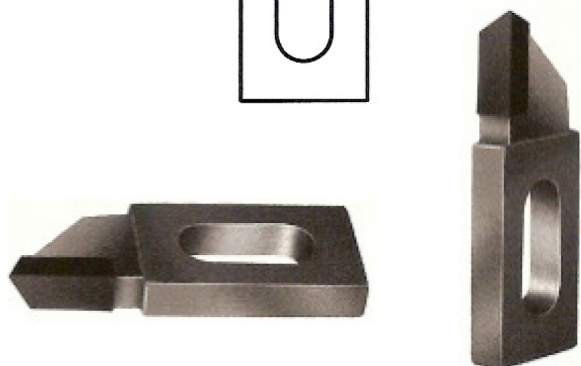

4695

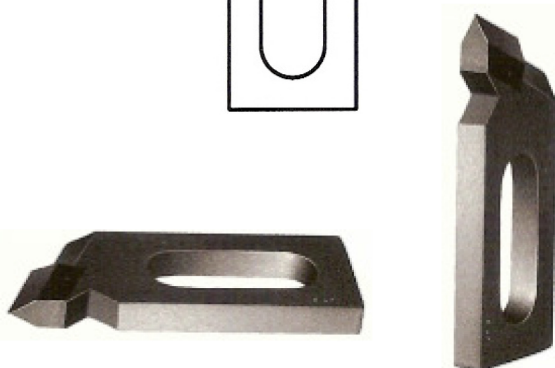
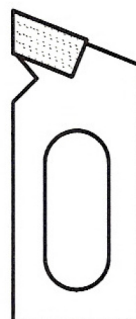

4698



4696



Coltelli per ugualizzatrice -

Knives for equalizing

Cuchillas para igualar -

备用刀

N 244

Ø 17

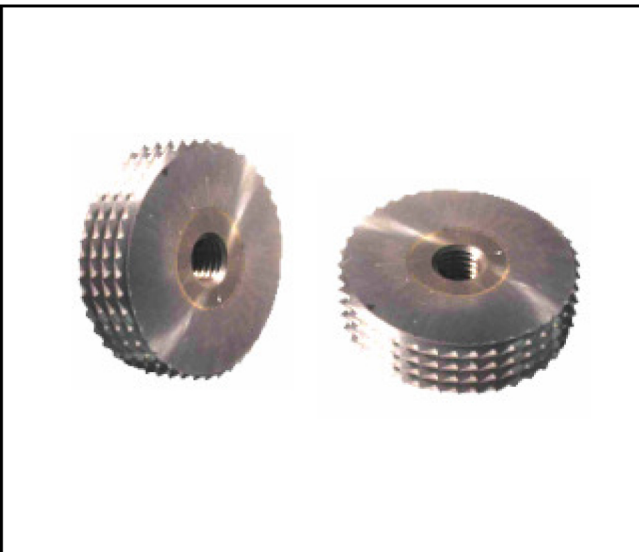
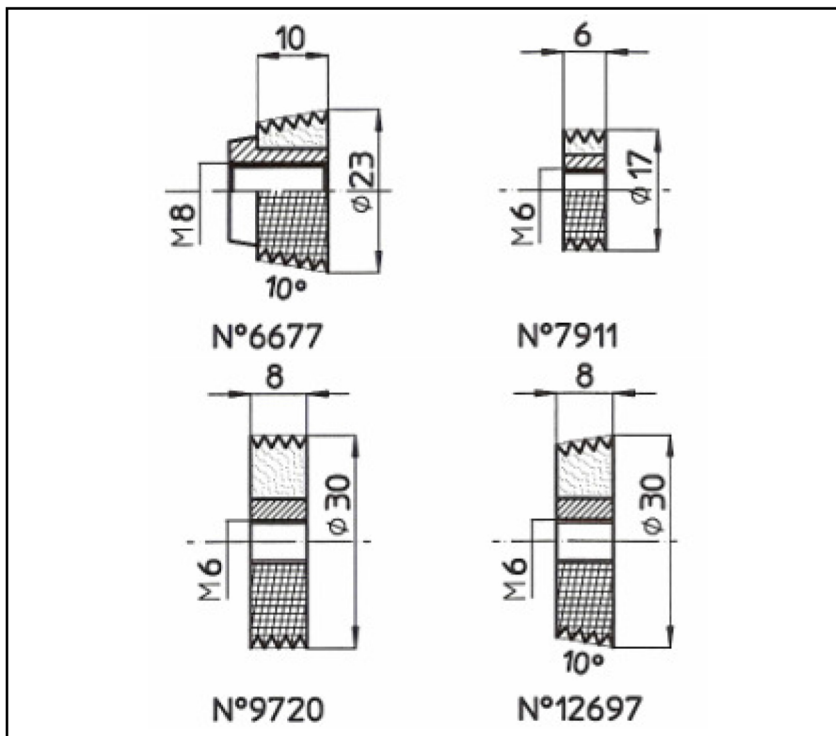

Raspa per **cardare** le tomaie
Denti in **carburo**

Carding tool for **roughing** the uppers
Carbide teeth

Herramientas para **cardar** cortes
Dientes de **carburo**

鞋面梳理机



Raspa per **cardare** le tomaie
Denti in grana di **carburo** o **diamante**

Carding tool for **roughing** the uppers
Carbide or **diamond** grains

Herramientas para **cardar** cortes
Dientes en polvo de **carburo** o **diamante**

鞋面梳理机

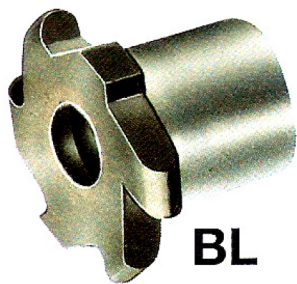

Fresini per **cucitura**
Lavorazione **manuale**

Switching chanel cutters
Hand working

缝制挖槽专用小铣刀



Fresini e coltelli per **cucitura**
Lavorazioni su **macchina**

Switching chanel cutters and knives
Machine working

缝制挖槽专用小铣刀



Coltello in **carburo integrale** per guardolo

Full carbide knife for welt

Cuchilla de **carburo** para cerco



Frese per **cinture** - Cutters for **belts**

Fresas para **cinturon** - 制腰带业专用铣刀